

KEITHLEY

MODEL 707
SWITCHING MATRIX

QUICK REFERENCE GUIDE

INTRODUCTION

This quick reference guide contains descriptions of various features and information concerning the operation of the Model 707. Also included are programming examples using various controllers.

Asyst is a registered trademark of Asyst Software Technologies.

Hewlett-Packard is a registered trademark of Hewlett-Packard Company.

IBM and AT are registered trademarks and PC/XT is a trademark of International Business Machines, Inc.

PC < > 488 is a registered trademark of Capital Equipment Corporation.

TABLE OF CONTENTS

SAFETY PRECAUTIONS	2
FRONT PANEL FAMILIARIZATION	3
DISPLAY MESSAGES	18
REAR PANEL FAMILIARIZATION	20
INSTALLING AND REMOVING CARDS	25
MASTER/SLAVE SYSTEMS	27
BASIC SWITCHING OPERATION	30
Selecting Make/Break and Break/Make Rows	31
Modifying a Relay Setup	31
Storing Setup and Sending to Relays	32
IEEE-488 PROGRAMMING	35
Device-Dependent Commands	35
Data Formats	40
Hit Key Commands	44
SRQ Mask and Serial Poll Byte	45
Status Words	46
PROGRAMS	52
IBM PC/XT/AT with CEC PC < > 488	52
IBM PC/XT/AT with CEC PC < > 488 and ASYST	54
HP Model 9000 Series 200/300	57

SAFETY PRECAUTIONS

1. Exercise extreme caution when a shock hazard is present at the test circuit. User-supplied lethal voltages may be present on the matrix card connector jacks. The American National Standards Institute (ANSI) states that a shock hazard exists when voltage levels greater than 30V RMS or 42.4V peak are present. A good safety practice is to expect that hazardous voltage is present in any unknown circuit before measuring.
2. Inspect the connecting cables and test leads for possible wear, cracks, or breaks before each use.
3. For maximum safety, do not touch the test cables or any instruments while power is applied to the circuit under test. Turn off the power and discharge any capacitors before connecting or disconnecting cables from the matrix card.
4. Do not touch any object which could provide a current path to the common side of the circuit under test or power line (earth) ground. Always make measurements with dry hands while standing on a dry, insulated surface capable of withstanding the voltage being measured.
5. Do not exceed the maximum allowable input of the matrix cards, as defined in the specifications and operation sections of their manual.

FRONT PANEL FAMILIARIZATION

POWER

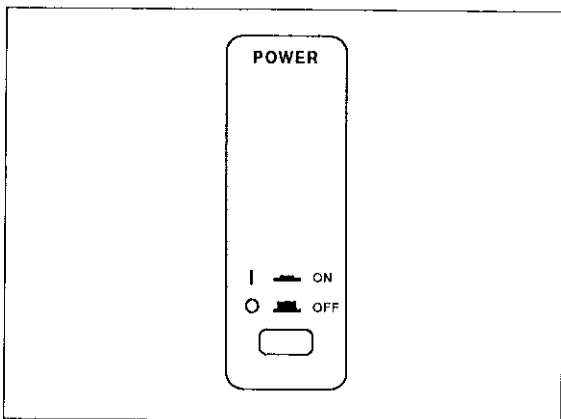

AC power switch turns the unit on or off.

CROSSPOINT DISPLAY GROUP

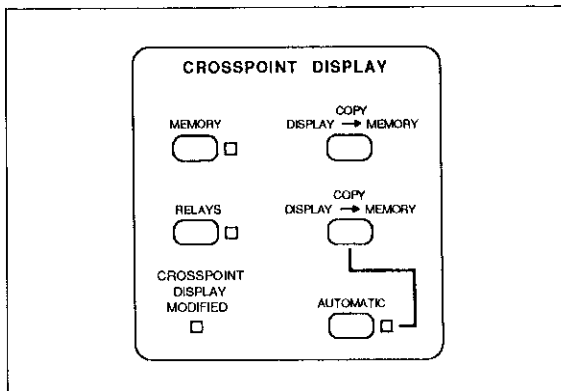

MEMORY—Displays a stored relay setup (from location shown in MEMORY STEP field) on the crosspoint display and lights the MEMORY indicator.

RELAY—Displays the current relay setup on the crosspoint display and lights the RELAYS indicator.

CROSSPOINT DISPLAY MODIFIED—Lights when changes are made to the crosspoint display (by front panel keys or light pen), making it different from the original configuration.

COPY DISPLAY → MEMORY—Copies the displayed crosspoint configuration to the location shown in the MEMORY STEP field.

COPY DISPLAY—RELAYS—Copies the displayed crosspoint configuration to the relays.

AUTOMATIC (COPY DISPLAY→RELAYS)—When this LED is lit, any change to the crosspoint display is sent to the relays at the same time. The pushbutton toggles the LED on and off. (To affect change in memory, display must be copied to memory.)

SCROLL GROUP

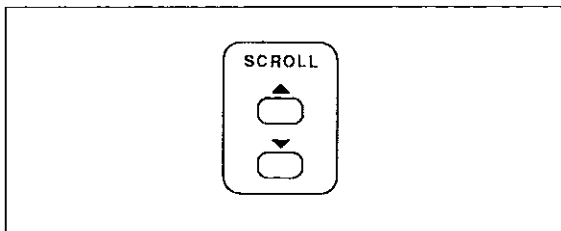

SCROLL ▲—If MEMORY indicator is lit, increments MEMORY STEP field and displays setup on crosspoint LEDs. If RELAYS indicator is lit, increments RELAY STEP field, displays setup on crosspoint LEDs, and sends setup to relays. Also used for scrolling up through a list of multiple choice parameters.

SCROLL ▼—Same actions as the SCROLL ▲ key except that it decrements and scrolls down.

MEMORY GROUP

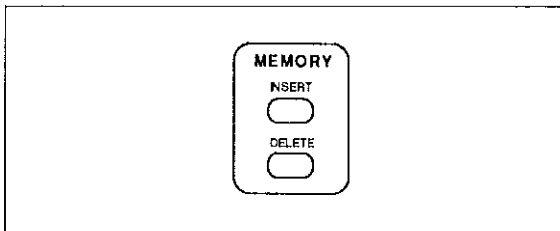

INSERT—Inserts a blank setup at the location shown in the MEMORY STEP Field. Moves higher stored setups up one memory location.

DELETE—Deletes the setup at the location shown in the MEMORY STEP field. Moves higher stored setups down one memory location.

MENU

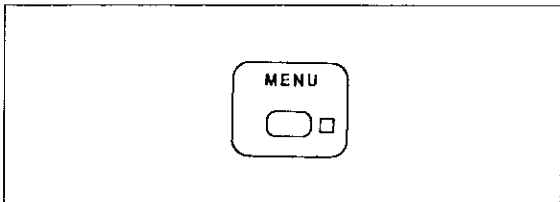

Message	Item Description
IN iii OUT ooo	View digital input, program digital output.
EXT TRIG FALL EXT TRIG RISE	Select which edge of external trigger pulse triggers Model 707 (falling or rising).
MATRIX RDY LO MATRIX RDY HI	Select matrix ready output level (active LO or HI).
STANDALONE MASTER	Select stand-alone or master/slave operation.
IEEE-488 nn	Program IEEE-488 bus address.
HWSETL nnn mS	View longest relay (hardware) settling time of cards in system.
n cccc	View slot number (n) and card label (cccc).
SELF TEST	Execute self test.
FACTORY INIT	Return to factory defaults. (All stored setups are cleared.)

Programmable parameters can be changed with the SCROLL or data entry keys and then pressing ENTER.

SWITCHING GROUP

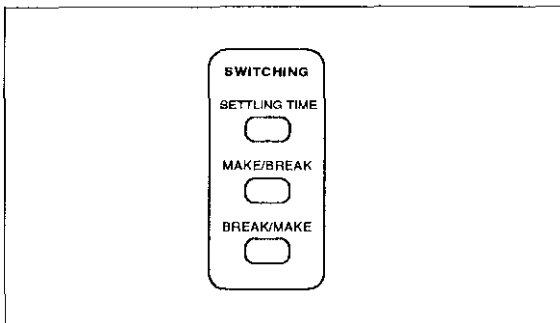

SETTLING TIME—Displays the current value of programmed settling time. (This delay begins after the relay settling time.) To change the value, enter between 0-65000msec and press ENTER.

MAKE/BREAK—Selects rows to operate as make/break (make-before-break) for all setups. First enter row designation (A-H), then press MAKE/BREAK to toggle the state for that row and immediately reprogram the Model 707 for the new operation.

BREAK/MAKE—Same action as MAKE/BREAK except that it selects break/make (break-before-make) rows. (Selecting a row for break/make de-selects it for make/break and vice versa.)

LOCAL

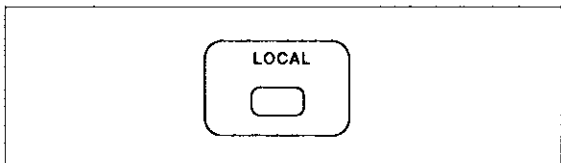

When in remote (REMOTE on), return the Model 707 to local mode (REMOTE off). It restores operation of other front panel controls unless LLO (Local Lockout) is in effect.

TRIGGER GROUP

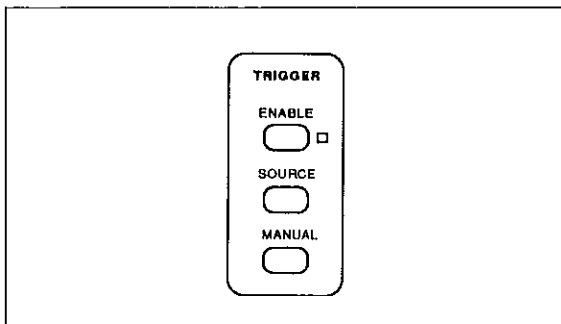

ENABLE—Toggles between triggers enabled and triggers disabled. When triggers are enabled, the LED is lit.

SOURCE—Displays current trigger source. Use **SCROLL** keys to display sources, then press **ENTER** to select the desired source:

- | | |
|---------------------|---|
| TRIG ON TALK | — IEEE-488 talk command |
| TRIG ON GET | — IEEE-488 GET command |
| TRIG ON X | — IEEE-488 X command |
| TRIG ON EXT | — External trigger pulse (rear panel input) |
| TRIG ON KEY | — Front panel MANUAL key only |

MANUAL—Generates a trigger from front panel if triggers are enabled (no matter which trigger source is selected). If the trigger source is **TRIG ON KEY**, only the **MANUAL** key generates a trigger.

DATA ENTRY

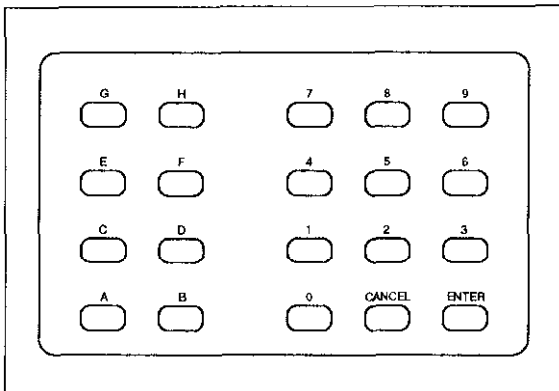

A-H, 0-9—These keys are for entering row/column addresses and setup locations, selecting make/break and break/make rows, and entering various numeric values.

CANCEL—If the value in the alphanumeric display has been modified, this key restores the current parameter value. If the value in the alphanumeric display has not been modified, this key returns the Model 707 to the previous display. **CANCEL** also exits from menu mode if no changes have been made.

ENTER—If the value in the alphanumeric display has been modified, pressing this key stores the parameter value. Also invokes immediate action items from the menu and exits menu mode (except when digital I/O is displayed).

RESET

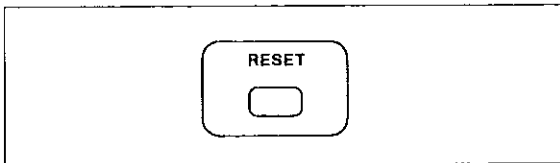

Performs the same functions as cycling power (all relays are opened, triggers are disabled, RELAY STEP to 000, MEMORY STEP to 001, etc.), except powerup self-checking and master/slave loop initialization.

CLEAR, OPEN, CLOSE

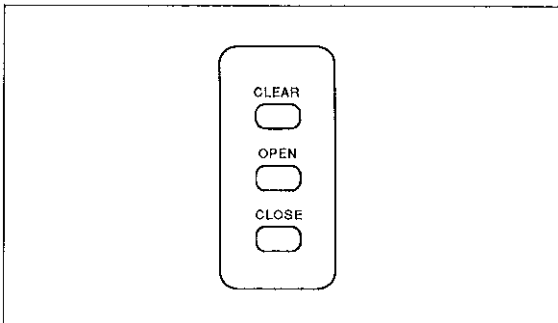

CLEAR—Turns off all crosspoint display LEDs. If the **AUTOMATIC (COPY DISPLAY → RELAYS)** indicator is lit, all relays are opened immediately.

OPEN—Turns off crosspoint LED of row/column shown on alphanumeric display. If the **AUTOMATIC (COPY DISPLAY → RELAYS)** indicator is lit, the corresponding relay opens immediately.

CLOSE—Same action as **OPEN** key except that it turns on the crosspoint LED and relay.

ALPHANUMERIC DISPLAY

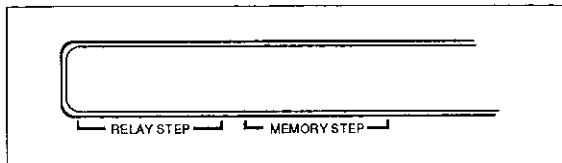

A 14-character display that can show:

- Error messages.
- Menu item selections.
- Last setup sent from memory to the relays (RELAY STEP field).
- Last setup recalled from memory to the crosspoint display (MEMORY STEP field).
- Trigger source.
- Programmed settling time.
- Alphanumeric key presses (row/column addresses, setup locations).

IEEE-488 STATUS INDICATORS

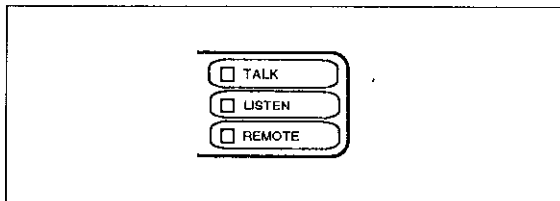

These three LED indicators apply to instrument operation over the IEEE-488 bus. The TALK and LISTEN indicators show when the unit has been addressed to talk or listen. REMOTE turns on to show when the unit is in the IEEE-488 remote state.

CROSSPOINT DISPLAY LEDs

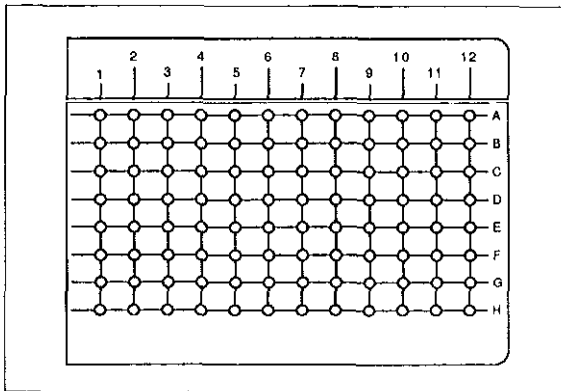

Show open and closed crosspoints of the current relay setup, a stored relay setup, or an edited relay setup. Each LED block of 8 rows by 12 columns shows on/off states of one card. States can be changed by front panel keys, triggers, or optional light pen. Crosspoint configurations can be stored in memory or sent to relays.

MAKE/BREAK and BREAK/MAKE LEDs

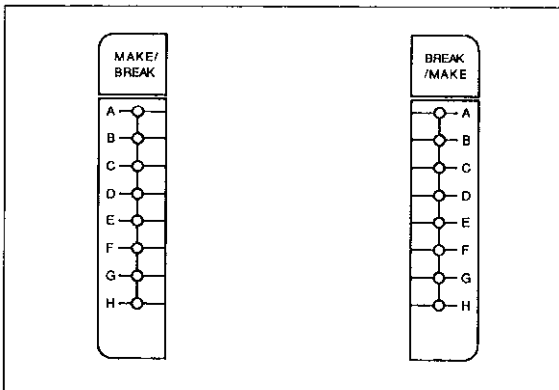

MAKE/BREAK ROW LEDs—Shows which rows are selected for make/break operation. The LEDs can be turned on or off by the MAKE/BREAK, BREAK/MAKE keys or an optional light pen.

BREAK/MAKE ROW LEDs—Same function as MAKE/BREAK row LEDs except for showing which rows are selected for break/make operation. Note that selecting a row for break/make de-selects it for make/break and vice versa.

LIGHT PEN

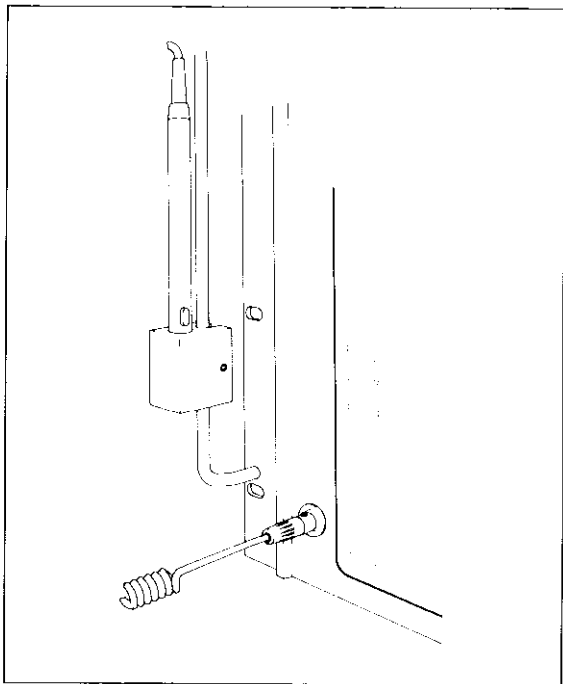

An optional input device for toggling the on/off state of the Crosspoint Display LEDs, MAKE/BREAK row LEDs, and BREAK/MAKE row LEDs. One light pen is used to control the LEDs of up to five Model 707 mainframes.

DISPLAY MESSAGES

Table 1 lists display messages not previously listed under menu operations or trigger sources.

Table 1. Additional Messages

Message	Description
CARD ID ERROR*	Checksum test failed on one or more matrix cards.
IDDC	Invalid device-dependent command.
IDDCO	Invalid device-dependent command option.
INVALID INPUT	Invalid crosspoint address, setup location, make/break or break/make row, or parameter out of range.
LIGHT PEN????	Light pen button pressed when pen was not pointed at crosspoint LED or make/break or break/make LED.
M/S ERROR*	Error in master/slave communication loop (overrun, parity, framing, count imbalance, or time-out).
M/S LOOP DOWN	One or more units connected in master/slave loop are not powered up.
NOT IN REMOTE	"X" character received over IEEE-488 bus but Model 707 is not in remote.

Table 1. Additional Messages (Cont.)

Message	Description
NOT SETTLED	Additional trigger received before programmed settling time expired (trigger is processed).
RAM FAIL*	Self-test detected error in RAM.
ROM FAIL*	Self-test detected checksum error in ROM.
SETUP ERROR*	Self-test detected checksum error in stored setup.
TRIG OVERRUN	An additional trigger was received before the Model 707 asserts the READY signal.

*Message remains displayed until next operation.

REAR PANEL FAMILIARIZATION

CARD SLOTS

The Model 707 accepts up to six plug-in matrix cards (8 rows by 12 columns) per mainframe.

MASTER/SLAVE

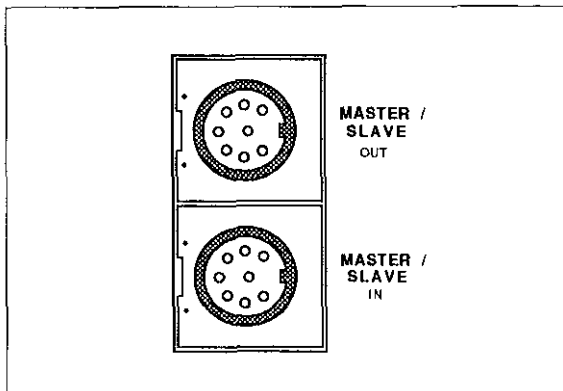

MASTER/SLAVE OUT—An 8-pin DIN connector for connecting a cable to the next mainframe in a master/slave daisy chain configuration.

MASTER/SLAVE IN—An 8-pin DIN connector for connecting a cable from the previous mainframe in a master/slave daisy chain configuration.

BNC JACKS

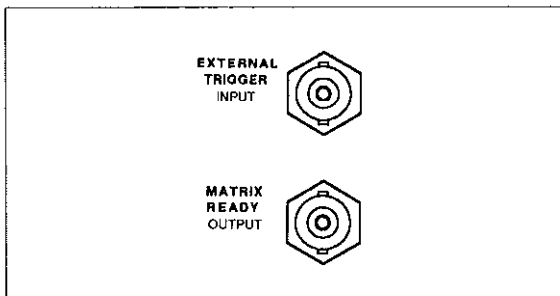

EXTERNAL TRIGGER INPUT—A BNC jack for applying a trigger pulse to change to the next relay setup, if triggers are enabled and TRIG ON EXT is selected as the source. Pulses must be TTL-compatible, negative- or positive-going (selected by a menu item), with a duration greater than 600nsec.

MATRIX READY OUTPUT—A BNC jack providing a TTL-compatible, high- or low-true level (selected by a menu item). It goes false when relays are switched and goes true after the sum of the relay settling time and the programmed settling time.

RELAY TEST

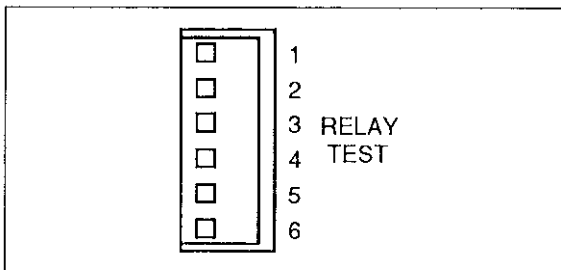

A 6-pin quick-disconnect terminal block with logic ground and four logic inputs for testing crosspoint relay closures. Wiring between this terminal block and rows A and B of any card in the group of cards to be tested is necessary for the test. Test connections are detailed in the card manuals.

DIGITAL I/O

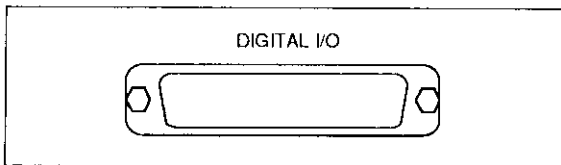

A DB-25 connector for the TTL-compatible digital I/O with data lines for eight inputs and eight outputs. It also con-

tains control lines for handshaking (Input Latch and Output Strobe). Input lines are viewed and output lines are programmed through a menu item.

IEEE-488 INTERFACE

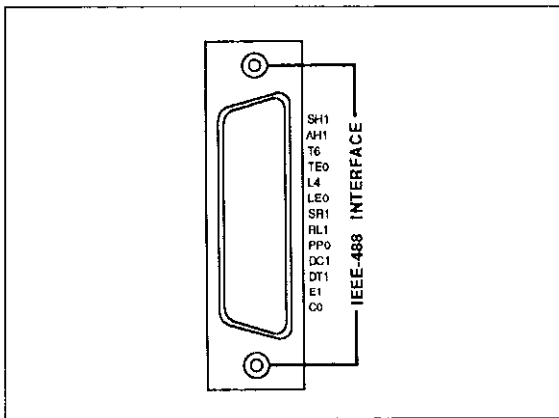

This connector interfaces the Model 707 to the IEEE-488 bus. IEEE-488 interface function codes are marked adjacent to the connector.

AC POWER

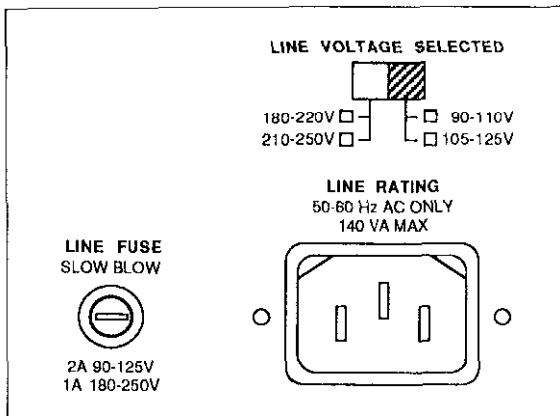

LINE VOLTAGE SELECTED—The position of this switch determines the operating voltage range of the instrument: 90-110V, 105-125V, or 180-220V, 210-250V.

AC RECEPTACLE—Power is applied through the supplied power cord to the 3-terminal AC receptacle.

LINE FUSE—The line fuse provides protection for the AC power line input. The fuse rating must match the line voltage setting.

INSTALLING AND REMOVING CARDS

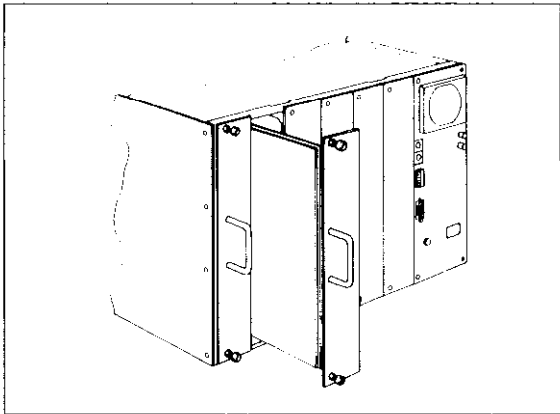

Figure 1. Installing a Card

WARNING

Turn off mainframe power and disconnect the line cord before installing or removing cards.

Install a card in the Model 707 as follows, using Figure 1 as a guide. Instructions specific to each card can be found in the appropriate card manual.

CAUTION

Do not touch the card surfaces, connectors, or components to avoid contamination that could degrade card performance.

1. Ensure that the access door on top of the mainframe is fully closed and locked down. (The bottom side of the access door has card guides.)
2. Remove the slot cover from the desired slot.
3. With one hand grasping the card's handle, and the other supporting its weight, line up the card with the card guides in the slot. Ensure that the component side is facing the fan of the mainframe.
4. Slide the card into the mainframe until it is fully seated in the backplane connectors. Finger-tighten the spring-loaded mounting screws at the back of the card to lock it in place.

WARNING

The mounting screws must be secured to ensure a proper chassis ground connection between the card and the mainframe. Failure to properly secure this ground connection may result in personal injury or death due to electric shock.

5. To remove a matrix card, first turn off the mainframe and disconnect the line cord. Ensure no voltage is applied from the user's circuit. Remove any internal cabling between cards through the unit's access door. Loosen the spring-loaded mounting screws and pull out the card by its handle.

MASTER/SLAVE SYSTEMS

A method of expanding a matrix with multiple mainframes is to connect up to five units in a master/slave configuration. This is done by connecting the rows of like cards in separate units and by connecting the units in a closed loop of DIN cables for communication and control. A master/slave system configuration appears as one unit with expanded card capacity. That is, only the master unit is addressed by the IEEE-488 bus controller and controlled from the front panel.

A master/slave configuration extends matrix rows yielding a long, narrow matrix. Figure 2 shows the connections between two units having Model 7071 cards. With five units, the maximum matrix size is 8 rows by 360 columns. Table 2 shows the column assignments for the maximum configuration.

If the mainframes of a master/slave configuration contain different card models, group like cards as much as possible. This will reduce the need to extend the analog buses with external cables.

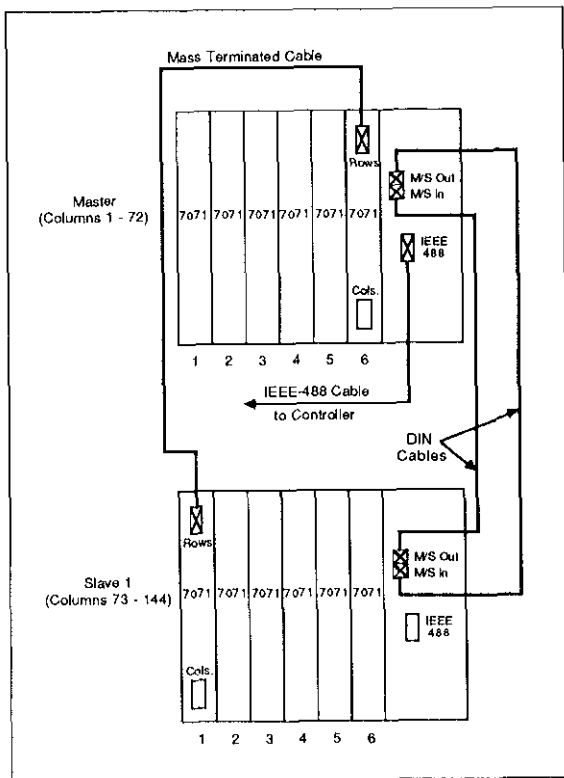

Figure 2. Example of Master/Slave Interconnect Cables

Table 2. Master/Slave Columns

Unit	Slot	Columns (1-12)
1 Master	1	1-12
	2	13-24
	3	25-36
	4	37-48
	5	49-60
	6	61-72
2 Slave 1	1	73-84
	2	85-96
	3	97-108
	4	109-120
	5	121-132
	6	133-144
3 Slave 2	1	145-156
	2	157-168
	3	169-180
	4	181-192
	5	193-204
	6	205-216
4 Slave 3	1	217-228
	2	229-240
	3	241-252
	4	253-264
	5	265-276
	6	277-288
5 Slave 4	1	289-300
	2	301-312
	3	313-324
	4	325-336
	5	337-348
	6	349-360

BASIC SWITCHING OPERATION

The following paragraphs will take you through a simple, general, step-by-step procedure to edit a matrix setup, store it in memory, and send the setup to the relays. Although the steps are described with front panel operations, the procedure can be performed over the IEEE-488 bus.

Figure 3 shows the setup data paths for these steps.

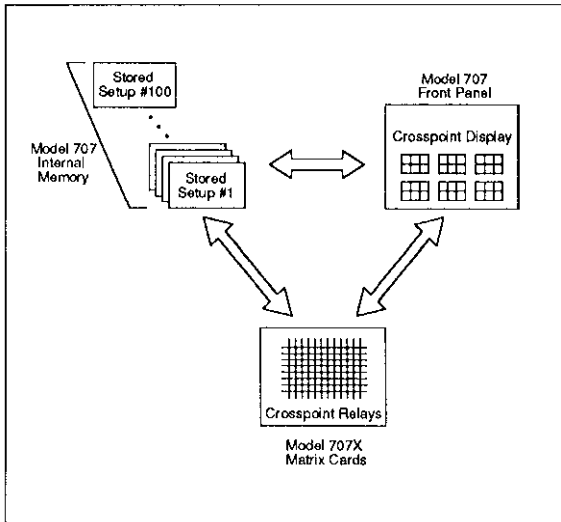

Figure 3. Setup Data Transfers

Selecting Make/Break and Break/Make Rows

Select make-before-break, break-before-make, or don't care operation for the rows. The selections will be in effect for all relay switching, even if a stored setup is not used. (As a general rule, use make/break operation for current sources and break/make for voltage sources.)

Use the data entry keys to select a row, then press MAKE/BREAK or BREAK/MAKE to toggle the state. (Selecting one state for a row de-selects it for the other.) This operation can also be performed with the light pen by using it to turn on/off the MAKE/BREAK and BREAK/MAKE LEDs.

Modifying a Relay Setup

Step 1: Select a Stored Setup

If you want to modify setup #1, just press the MEMORY key. The MEMORY indicator light will light. To select another setup (up to location 100), use the numeric data entry keys (leading zeros are not necessary), then press the MEMORY key.

Step 2: Modify the Displayed Setup

Use the data entry keys to select a crosspoint address (A1 through H72), then press the OPEN or CLOSE key. Keystrokes will be shown on the alphanumeric display and the CROSSPOINT DISPLAY MODIFIED indicator will light.

If you have the optional light pen, toggle the state of a cross-point LED by holding the light pen perpendicular to and touching the front panel overlay and pressing the light pen button.

Continue editing with the front panel key or light pen until the crosspoint display shows the desired configuration.

Storing Setup and Sending to Relays

Step 1: Storing Setup in Memory

To store the modified setup at the location shown in the MEMORY STEP field, just press the COPY DISPLAY→MEMORY KEY. This action overwrites the old setup data at that location with the newly modified setup.

To select a different memory location, key in a valid location number, then press the COPY DISPLAY→MEMORY key. The MEMORY STEP field is set to the new location.

Step 2A: Sending Setup to Relays

To make the newly modified setup the current relay setup, just press the COPY DISPLAY→RELAYS key. The relay states will be changed to reflect the modified setup data. If the MEMORY LED is lit, the RELAY STEP field will be set equal to the MEMORY STEP field. In effect, this copies a setup from memory to the relays.

Step 2B: Triggering Setup to Relays

If you modified setup #1 and restored it to memory at the same location, a single trigger will copy the setup to the relays. Do this by pressing the trigger SOURCE key, scrolling to the "TRIG ON KEY" display and pressing ENTER. Then press the trigger ENABLE key. Pressing the trigger MANUAL key will copy setup #1 to the relays and set the RELAY STEP field to 001.

IEEE-488 PROGRAMMING

DEVICE-DEPENDENT COMMANDS

External Trigger	
A0	Falling edge triggers Model 707
A1	Rising edge triggers Model 707

Matrix Ready	
B0	Negative true Matrix Ready output
B1	Positive true Matrix Ready output

Close Crosspoint	
Crc(,rc)...(,rc)	Close crosspoints of setup indicated by edit pointer (rows A-H, cols. 1-360)

Display	
Dcccccccccccccc	Display ASCII characters (14 max.)
DX	Return alphanumeric display to normal

Edit Pointer

E0	Point to current relay setup
En	Point to stored relay setup (1-100)

Enable/Disable Triggers

F0	Disable triggers
F1	Enable triggers

Data Format

G0	Full output, all data in one talk
G1	Full output, one mainframe row per talk
G2 or G3	Inspect output, all data in one talk
G4	Condensed output, all data in one talk
G5	Condensed output, one mainframe per talk
G6	Binary output, all data in one talk
G7	Binary output, one mainframe per talk

Hit Key

Hn	Emulate front panel key press (1-41)
----	--------------------------------------

Insert Blank Setup

In	Insert blank setup in memory (1-100)
----	--------------------------------------

Self-test

J0	Perform self-test
----	-------------------

EOI and Hold-off

K0	Send EOI, hold-off on X until Ready
K1	No EOI, hold-off on X until Ready
K2	Send EOI, do not hold-off on X
K3	No EOI, do not hold-off on X
K4	Send EOI, hold-off on X until Matrix Ready
K5	No EOI, hold-off on X until Matrix Ready

Download Setups

Lbbb...X	Download setups from controller to Model 707
----------	--

SRQ

M0	SRQ disabled
M1	not used
M2	Front panel key press
M4	Digital I/O interrupt
M8	Matrix Ready
M16	Ready for trigger
M32	Error
M128	not used

Open Crosspoint

Nrc(,rc)...(,rc)	Open crosspoints of setup indicated by edit pointer (rows A-H, cols. 1-360)
------------------	---

Digital Output

Onnn	Set states of digital output lines (000-255)
------	--

Clear Crosspoints

P0	Open all crosspoint relays
Pn	Clear all crosspoints of stored setup (1-100)

Delete Setup

Qn	Delete setup from memory (1-100)
----	----------------------------------

Restore Defaults

R0	Restore factory defaults
----	--------------------------

Programmed Settling Time

Sn	Program settling time in msec (0-65000)
----	---

Trigger	
T0 or T1	Trigger on talk
T2 or T3	Trigger on GET
T4 or T5	Trigger on X
T6 or T7	Trigger on External Trigger pulse
T8 or T9	Trigger on front panel MANUAL key only

Status	
U0	Send machine status word
U1	Send error status word
U2,n	Output setup "n" (0-100) with current G format
U3	Send RELAY STEP pointer
U4	Send number of slaves
U5,u	Send model number of each card in unit "u" (0-4)
U6	Send relay settling time
U7	Send digital input of unit
U8	Send RELAY TEST input

Make/Break	
Wabcd efgh	Select rows for make/break operation (00000000 - 11111111)

Break/Make	
Wabcd efgh	Select rows for break/make operation (00000000 - 11111111)

Execute	
X	Execute commands

Terminator	
Y0	<CR> <LF>
Y1	<LF> <CR>
Y2	<CR>
Y3	<LF>

Copy Setup	
Z0,n	Copy current relay setup to memory location "n" (1-100)
Zn,0	Copy setup from memory location "n" (1-100) to relays
Zm,n	Copy setup from location "m" (0-100) to location "n" (0-100)

DATA FORMATS

When uploading setup data to the controller, the data will be in one of the formats that follow. The example data shown is for setup #3 of a stand-alone unit with crosspoints A1, A2, B19, B20, C27, C28, D37, D38, F61, and F62 being closed.

SETUP 003		CARD 1 COLS		CARD 8 COLS	
A	XX				
B		XX			
C			XX		
D				XX	
E					XX
F					
G					
H					
I					

Notes :

1. Slaves 2-4 have the same format as Slave 1.
2. Carriage returns and line feeds are not sent. They are shown here to improve readability.
3. Spacing between columns is one ASCII space.

G0 and G1 Full Output

A001,A002,B019,B020,C027,C028,D037,D038,F061,F062

G2 and G3 Inspect Output

```

SETUP  UNIT
  ↓    ↓
0003 00
010100000000 000000000000 ~CARD 1, COLS 1-12
000000000000 020200000000
000004040000 000000000000
080800000000 000000000000
000000000000 000000000000
202000000000 000000000000 ~CARD 6, COLS 61-72
XX
    ↑
CHECKSUM
  
```

G4/G5 Data	Corresponding Row
00	none
01	A
02	B
04	C
08	D
10	E
20	F
40	G
80	H

G4 and G5 Condensed Output

HIT KEY COMMANDS

Table 3 lists hit key commands sent over the IEEE-488 bus to emulate front panel key presses.

Table 3. Hit Keys

Command Key	Command Key
H1 MEMORY	H22 H
H2 RELAYS	H23 F
H3 COPY DISPLAY→MEMORY	H24 D
H4 COPY DISPLAY→RELAYS	H25 B
H5 AUTOMATIC	H26 7
H6 SCROLL ▲	H27 4
H7 SCROLL ▼	H28 1
H8 INSERT	H29 0
H9 DELETE	H30 8
H10 MENU	H31 5
H11 SETTLING TIME	H32 2
H12 MAKE/BREAK	H33 CANCEL
H13 BREAK/MAKE	H34 9
H14 LOCAL	H35 6
H15 ENABLE	H36 3
H16 SOURCE	H37 ENTER
H17 MANUAL	H38 RESET
H18 G	H39 CLEAR
H19 E	H40 OPEN
H20 C	H41 CLOSE
H21 A	

SRQ MASK AND SERIAL POLL BYTE

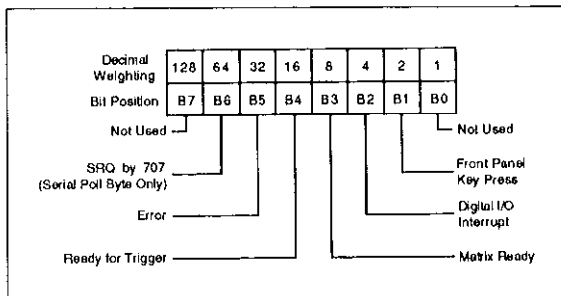

STATUS WORDS

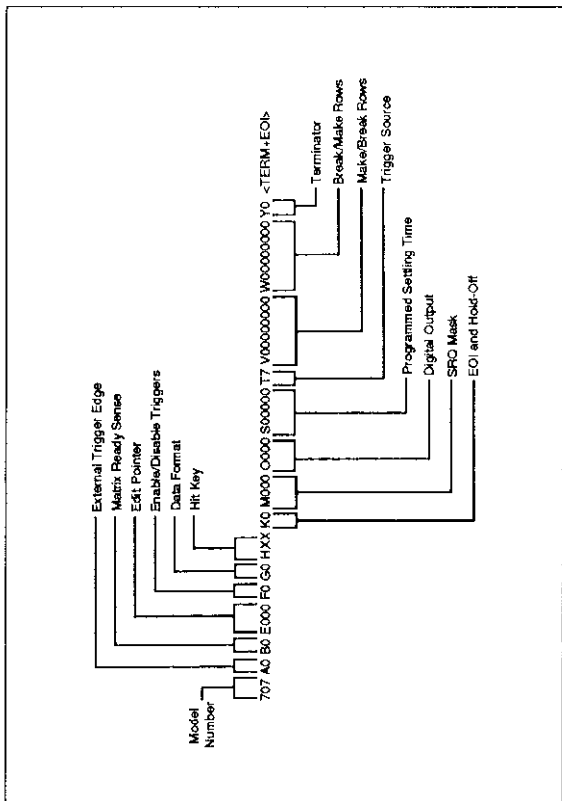

U0 Machine Status Word

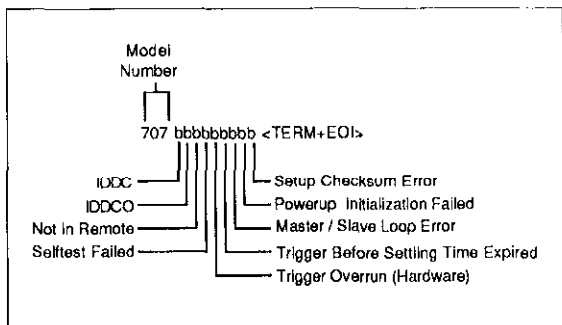

U1 Error Status Word

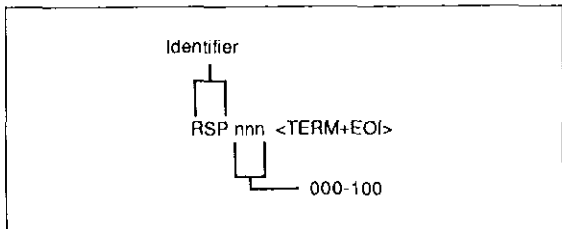

U3 Relay Step Pointer

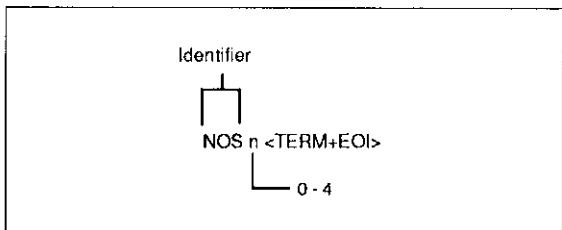

U4 Number of Slaves

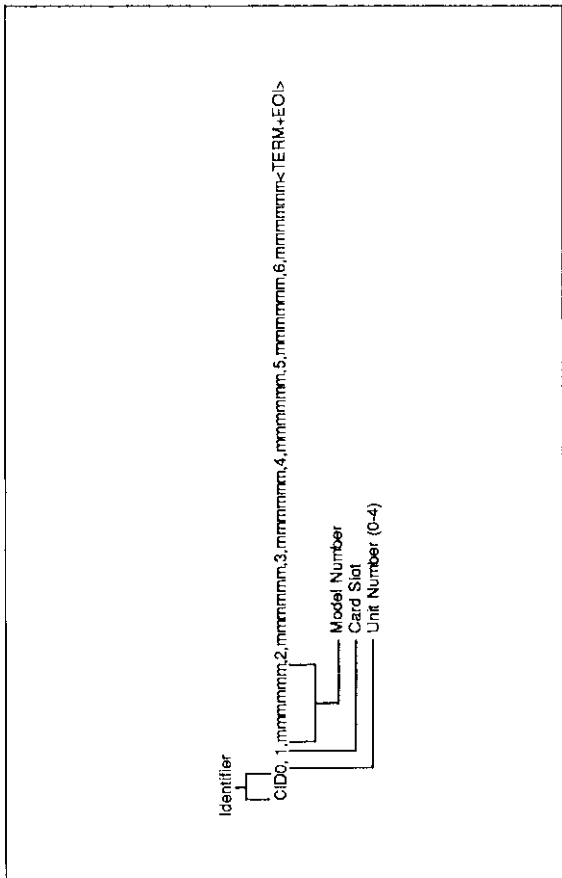

U5 Card Identifications

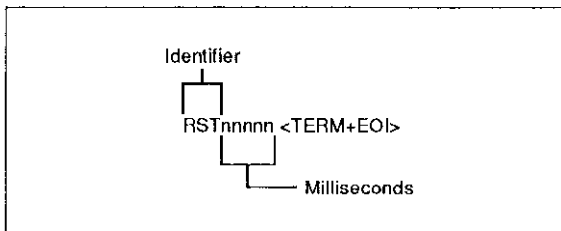

U6 Relay Settling Time

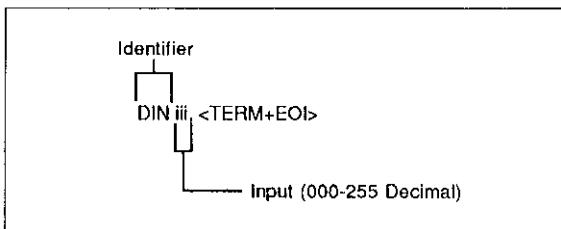

U7 Digital Input

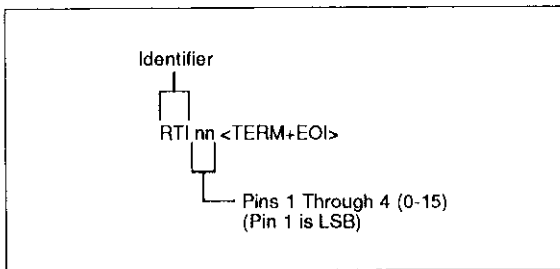

U8 Relay Test Input

PROGRAMS

IBM PC/XT/AT with Capital Equipment Corporation PC < > 488 Interface (Kelthley PC-488-CEC)

The following program sends a command string from an IBM PC/XT/AT computer to the Model 707 and displays the response on the CRT. The computer must be equipped with a CEC interface card and DOS 2.0 (or later revision) operating system.

DIRECTIONS

1. Using the front panel menu feature, set the primary IEEE-488 address of the Model 707 to 18.
2. With the power off, connect the Model 707 to the IEEE-488 interface card installed in the IBM computer.
3. Type in BASICA on the computer keyboard to get into the IBM interpretive BASIC language.
4. Enter the lines below using the return key after each line.
5. Run the program and type in the desired command string at the ENTER COMMAND STRING? prompt. For example, to close crosspoint A1, type in CA1X and press the return key. (The Model 707 software revision, e.g. 707A01, will then appear on the computer display for device-dependent commands which have no response.)

If the command "G2U2,0X" is typed in at the prompt, the response will be a display of the closed crosspoints of the current relay setup.

PROGRAM	COMMENTS
10 DEF SEG=&HC400	' Memory address
20 INITIALIZE=0	' Offset address of routine
30 SEND=9:ENTER=21	' Routine addresses
40 MY_ADDRESS%=21	' Set PC < > 488 address
50 INST_ADDRESS%=18	' Set 707 address
60 CONTROLLER%=0	' Set for system control
70 CALL INITIALIZE (MY_ADDRESS%, CONTROLLER%)	' Initialize system
80 LINE INPUT "ENTER COMMAND STRING: "; CMD\$	' Prompt for string
90 CALL SEND (INST_ADDRESS%, CMD\$, STATUS%)	' Send command string
100 RESPONSE\$=SPACE\$(80)	' Make room for data
110 CALL ENTER (RESPONSE\$, LENGTH%, INST_ADDRESS%, STATUS%)	' Get response from 707
120 PRINT RESPONSE\$	' Display response
130 GOTO 80	' Repeat
140 END	

IBM PC/XT/AT with Capital Equipment Corporation PC < > 488 Interface and ASYST Software

The ASYST program listed here sends a command string from an IBM PC/XT/AT computer to the Model 707 and displays the response on the CRT. The computer must be equipped with a CEC interface card and DOS 2.0 (or later revision) operating system.

The optional GPIB/IEEE-488 software module for the ASYST package is required. Hardware requirements for ASYST include: 640K RAM, math coprocessor, parallel port, and hard drive (recommended).

DIRECTIONS

1. Using the front panel menu key, set the primary IEEE-488 address of the Model 707 to 18.
2. With the power off, connect the Model 707 to the IEEE-488 interface card installed in the IBM computer.
3. Boot ASYST software from DOS. You will get an OK prompt.
4. Use the <F2> key to enter the Main Configuration Menu. In addition to the usual configuration requirements of ASYST, the GPIB must be configured.

From the Overlay Configuration Menu, select overlays GPIB Master and Type 1 NEC GPIB Driver.

From the GPIB Configuration Menu, select a bus number, board type (National GPIB-PC1 or GPIB-PC2), memory address (2B8), primary address (0), and interrupt line.

5. Save your changes and return to the OK prompt.
6. Use the command line editor (EDIT 707.DMO) to enter the following program. Save the program and exit the editor.
7. When prompted, load the program with the L key, or type LOAD 707.DMO from the OK prompt.
8. When the program loads properly, type MAIN from the OK prompt to start execution.
9. Type in the desired command string at the "Enter command string:" prompt. For example, to close crosspoint A1, type in CA1X and press the return key. (The Model 707 software revision, e.g. 707A01, will then appear on the computer display for device-dependent commands which have no response.)

If the command "G2U2,0X" is typed in at the prompt, the response will be a display of the closed crosspoints of the current relay setup.

10. Type <Control-Break> to exit the program loop of 707.DMO and return to the OK prompt. The program-defined words can be removed from the ASYST dictionary by typing FORGET 707.

PROGRAM	COMMENTS
BUS.INIT	\ Initialize bus
SEND.INTERFACE.CLEAR	\ Take control of bus
REMOTE.ENABLE.ON	\ Allow remote operation
SYNCHRONOUS.GPIB	\ Make sure ASYST is in sync. mode
?GPIB.DEVICES	\ List controller parameters
18 GPIB.DEVICE 707	\ Set 707 address and name

EOI.ON	\ Enable end or identify
EOS.ON	\ Enable end of string terminator
10 EOS.CHARACTER	\ Use LF terminator
1000 TIMEOUT	\ Set timeout of 1sec
?GPIB.DEVICE	\ List 707 parameters
100 STRING COMMAND	\ Allocate 100 bytes for user input
100 STRING RESPONSE	\ Allocate 100 bytes for 707 response
;	
: GET.INPUT	\ Definition for user input
CR " Enter command string: "	\ Prompt user
"INPUT COMMAND " :=	\ Get DDCs
;	
: MAIN	\ Definition for main program
BEGIN	\ Start loop
ME	\ Make controller current device
GET.INPUT	\ Get DDCs from user
707	\ Make 707 current device
COMMAND GPIB.WRITE	\ Send DDCs to 707
RESPONSE GPIB.READ	\ Get response
CR RESPONSE "TYPE	\ Display response
AGAIN	\ Return for more commands
;	

Hewlett-Packard Model 9000 Series 200/300

The following program sends a command string to the Model 707 from a Hewlett-Packard Model 9000 Series 200/300 computer and displays the response on the computer CRT. The computer must be equipped with HP BASIC 4.0.

DIRECTIONS

1. Using the front panel menu feature, set the primary IEEE-488 address of the Model 707 to 18.
2. With the power off, connect the Model 707 to the IEEE-488 interface card installed in the HP computer.
3. Enter the lines in the program below, using the ENTER/RETURN key after each line.
4. Press the RUN key and type in the desired command string at the COMMAND STRING prompt. For example, to close crosspoint A1, type in CA1X and press the ENTER/RETURN key. (The Model 707 software revision, e.g. 707A01, will then appear on the computer display for device-dependent commands which have no response.)

If the command "G2U2,0X" is typed in at the prompt, the response will be a display of the closed crosspoints of the current relay setup.

PROGRAM	COMMENTS
10 DIM A#[50],B#[50]	
20 REMOTE 718	! Place 707 in remote.
30 LINPUT "COMMAND STRING: ",A#	! Prompt for and input command.
40 OUTPUT 718:A#	! Address 707 to listen, send string.
50 ENTER 718:B#	! Address 707 to talk, input response.
60 PRINT B#	! Display response string.
70 GOTO 30	! Repeat.
80 END	

